

## AMF BOWLING EQUIPMENT PRE-INSTALLATION PLANNING GUIDE

### 1. Location

- A. Residential area such as apartments and houses
- B. Public offices, companies and schools
- C. Commercial districts and stations with places easy of access
- D. Area with parking lots
- E. Distribution condition of bowling center around your area

### 2. Size

#### Lane Width

LANE NO.	WIDTH (mm)	LANE NO.	WIDTH (mm)
2	3454	22	37294
4	6840	24	40685
6	10224	26	44069
8	13608	28	47454
10	16993	30	50838
12	20337	32	54223
14	23762	34	57607
16	27146	36	60992
18	30531	38	64376
20	33915	40	67761

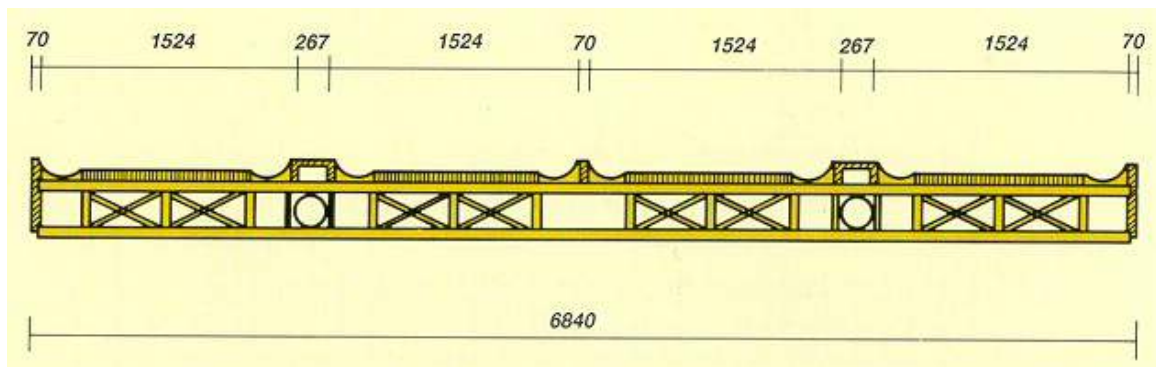

The above dimensions are uninterrupted lane widths only. If there are columns, walls, or passages between lanes, the overall width of lane shall be added as much as the width of them.

## Building Length

Overall Length	30,550 to 31,460
Bowler's Seating Area	3,660 to 4,570
Approach and Lane Area	24,079
Pinsetter Area	1,270
Mechanic Room	1,500

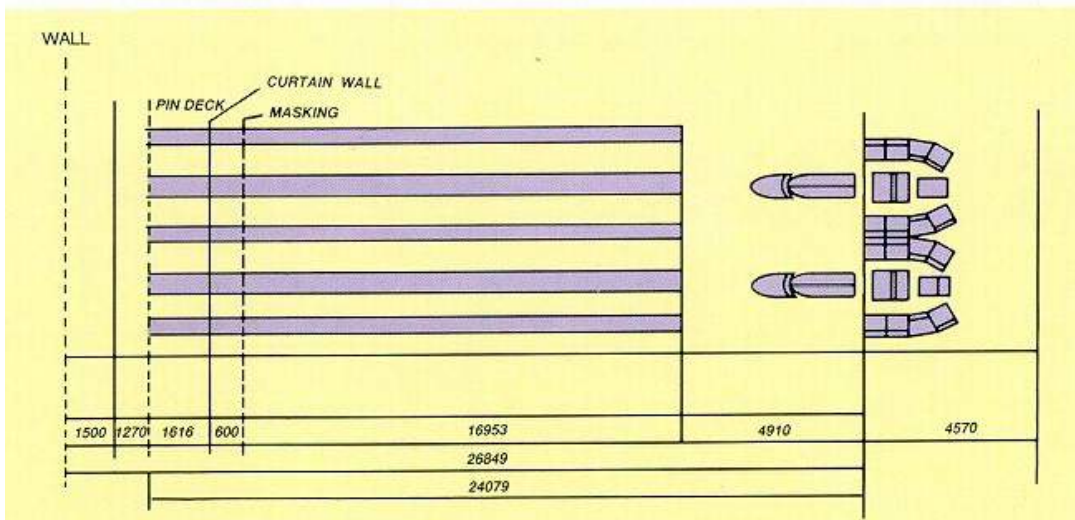
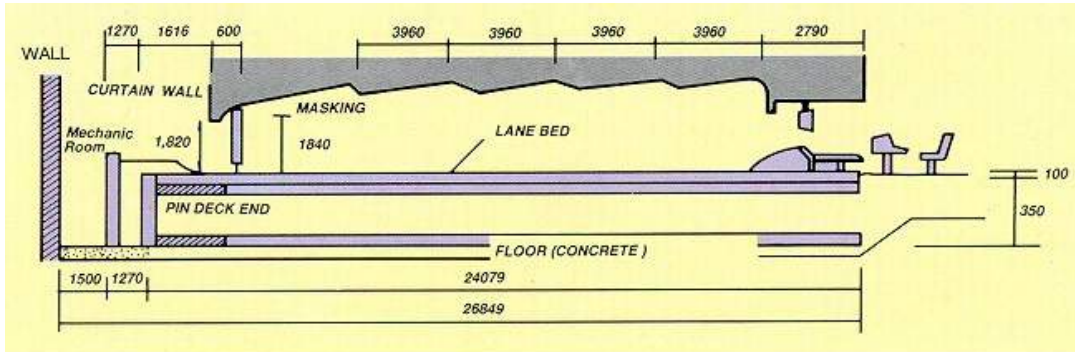

## 3. COLUMN SPACING

The columns should be free from the approach area (4,910mm) to foul line (609.6mm). And the column spacing requires the width of column itself plus 12.7(mm) on each side of column, to diminish transmission of noise.

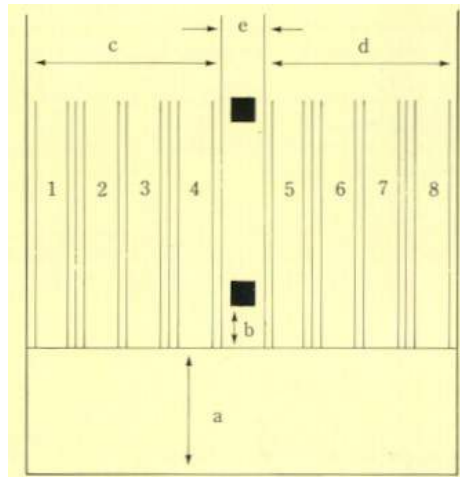

- a: Approach (4,910mm) is clear
- b: Foul line to Column (609.6mm, min.)
- c: 4 lane = 6,840 mm
- d: 4 lane = 6,480 mm
- e: width of column  
(plus 12.7 mm on each side of column)

#### 4. SIDE AISLE

The side aisle serves as an indoor route for people to the pinsetters and storage areas. It is desirable to be 1,000 (mm) of the width of a side aisle.

#### 5. TEMPERATURE & HUMIDITY

In summer : 26° - 27° C

In winter : 20° - 21° C

45%, RH.7

#### 6. LIGHTINGS

All lightings are to be installed before lane installation and controlled by the front desk switch. Refer to the following (unit = luxes):

- a. Lane surface between foul line and curtain wall : 200 – 250
- b. Pinsetter area : 350
- c. Mechanic work bench : 750 - 1,000
- d. Spectator area : 100 - 300
- e. Score recording table : 400 - 600
- f. Bowler area : 100 - 150
- g. Approach area : 50 - 100

- LIGHTING

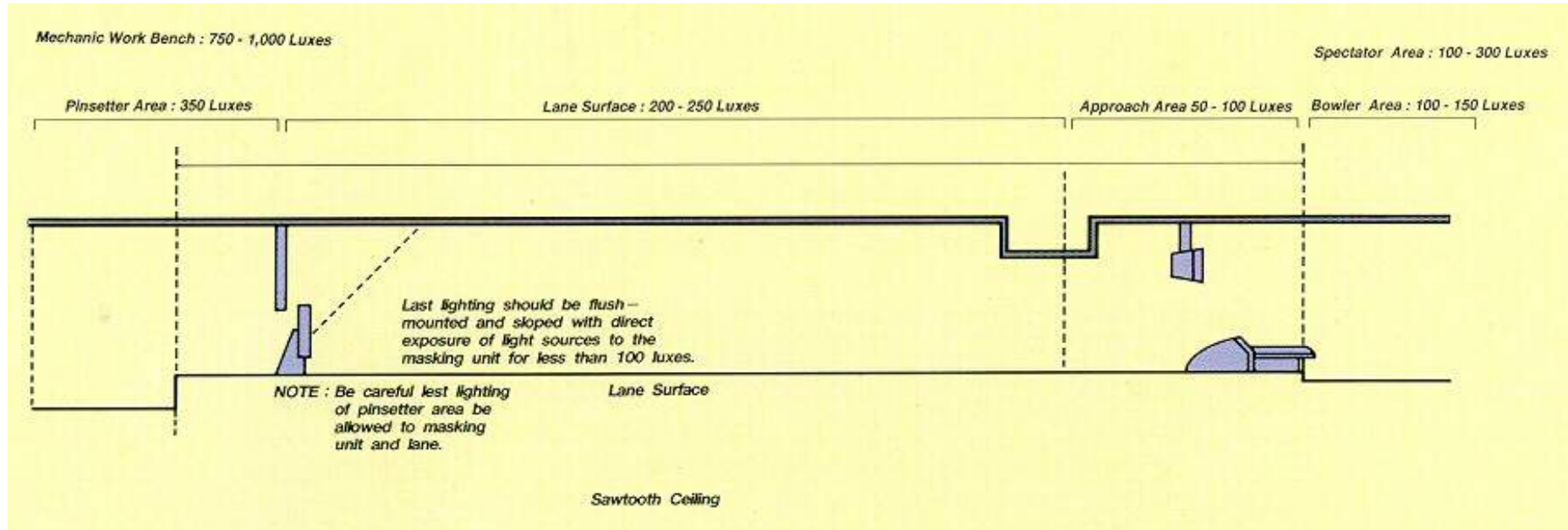

- 82-90XL PINSPOTTER SIDEVIEW

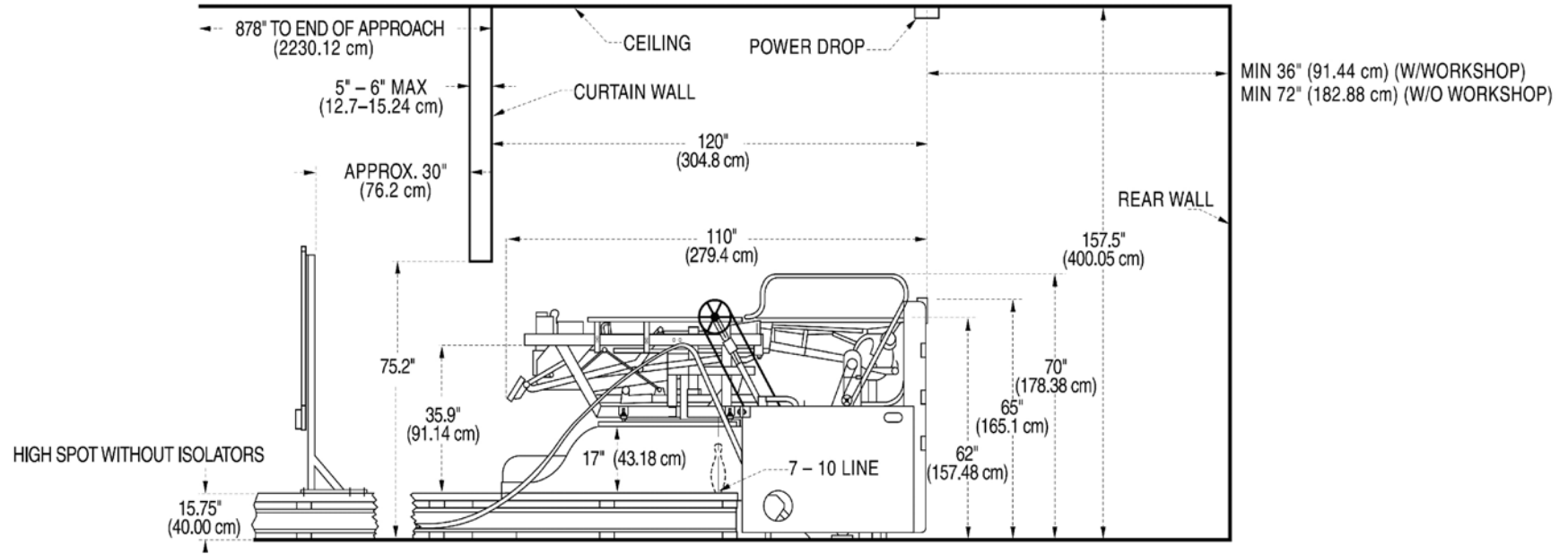

- 4-LANE LAYOUT

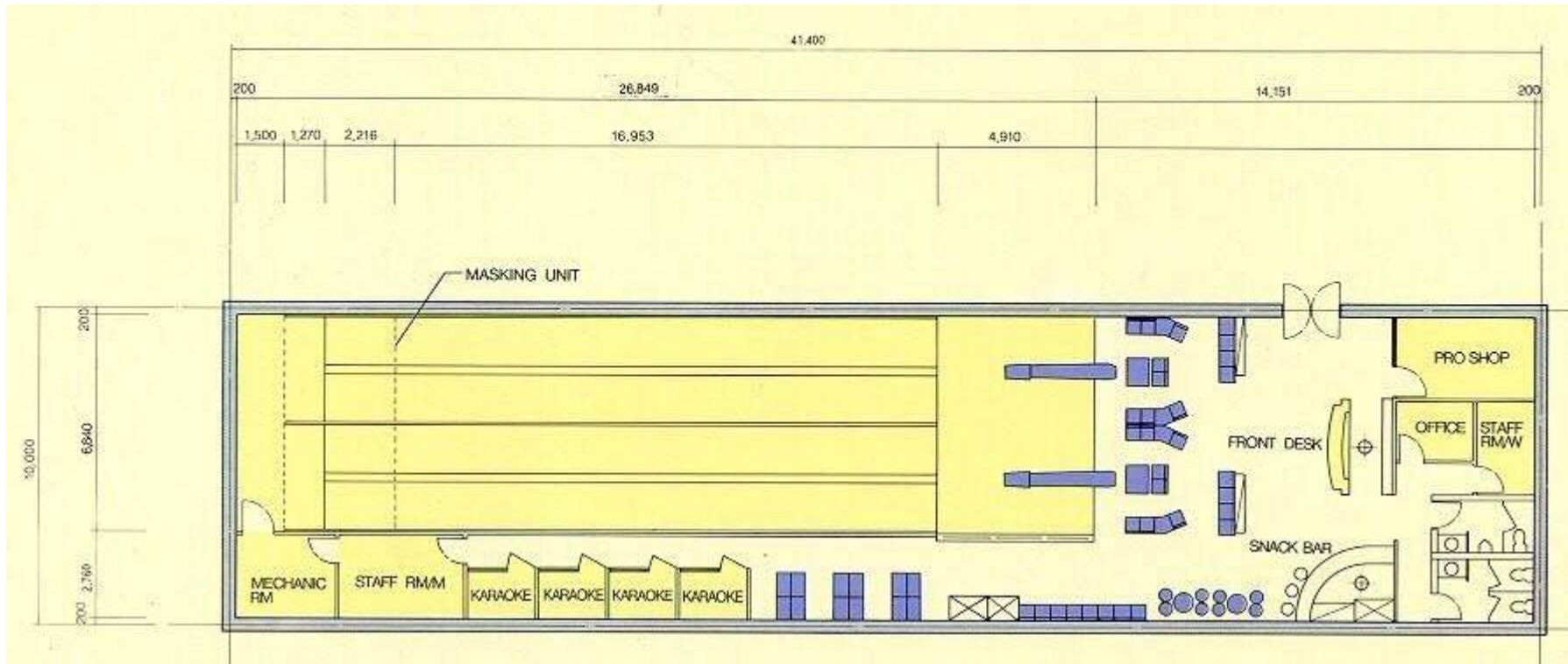

- 6-LANE LAYOUT

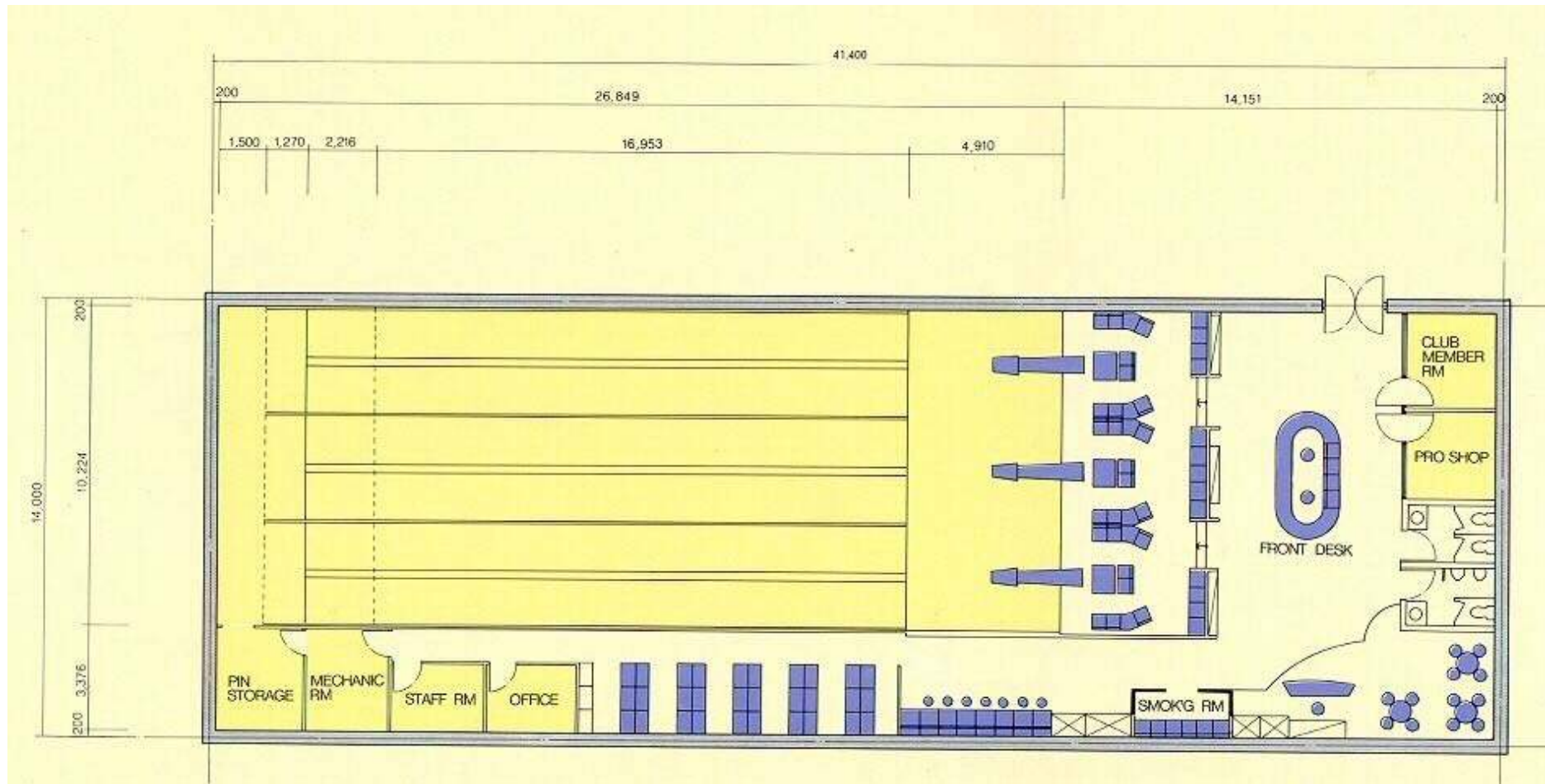

- 8-LANE LAYOUT

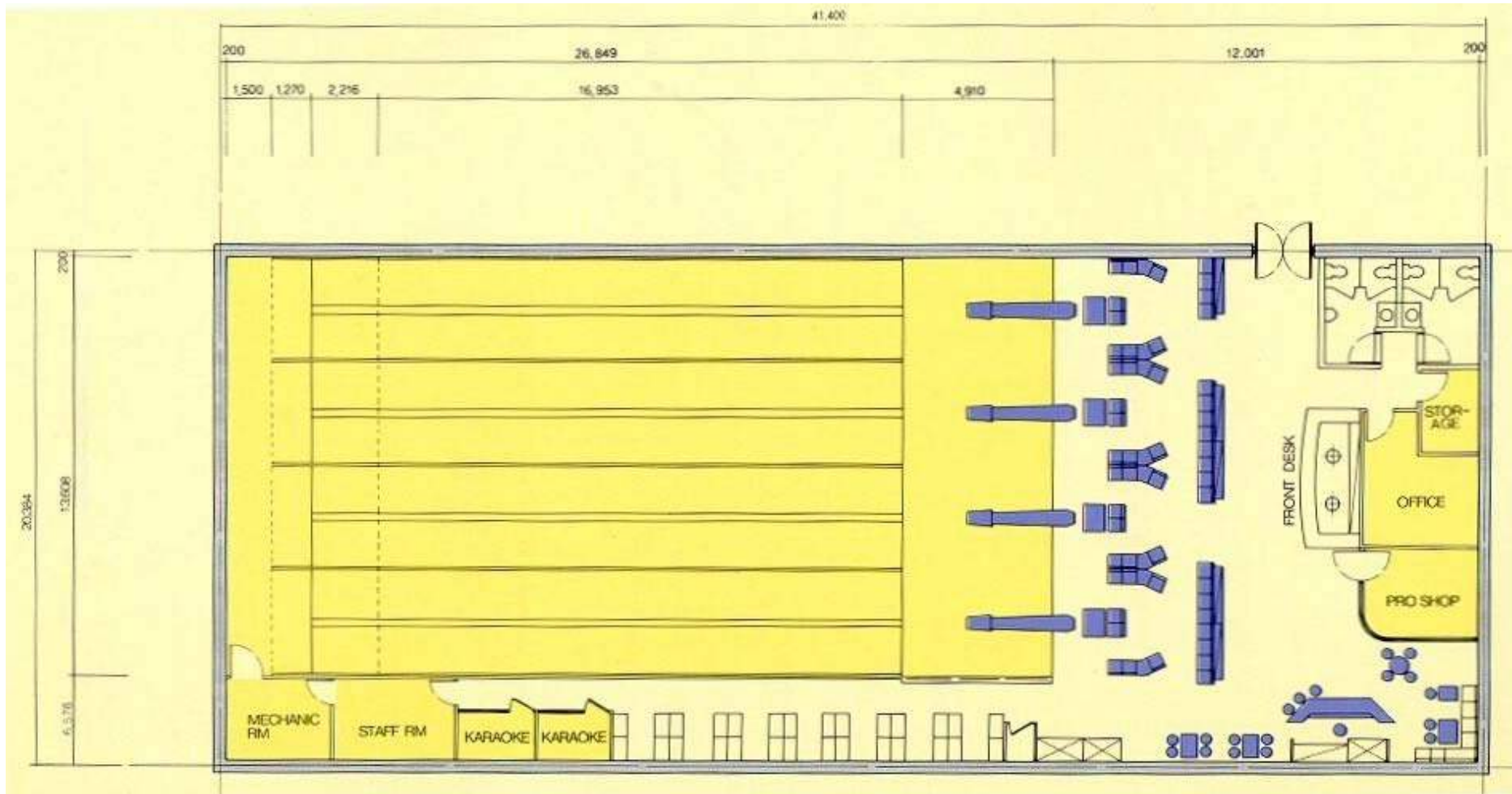



- 10-LANE LAYOUT

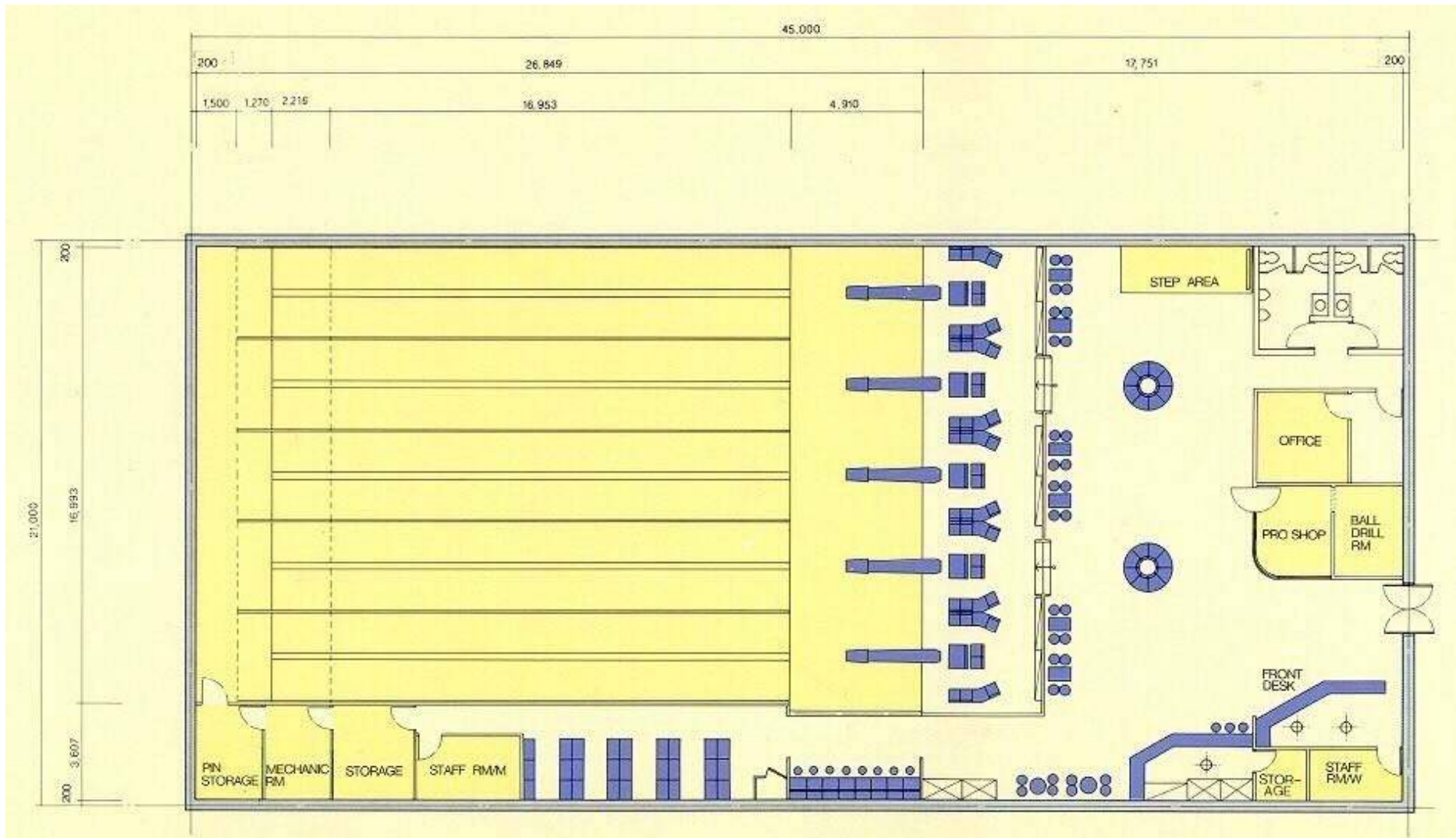

- 12-LANE LAYOUT

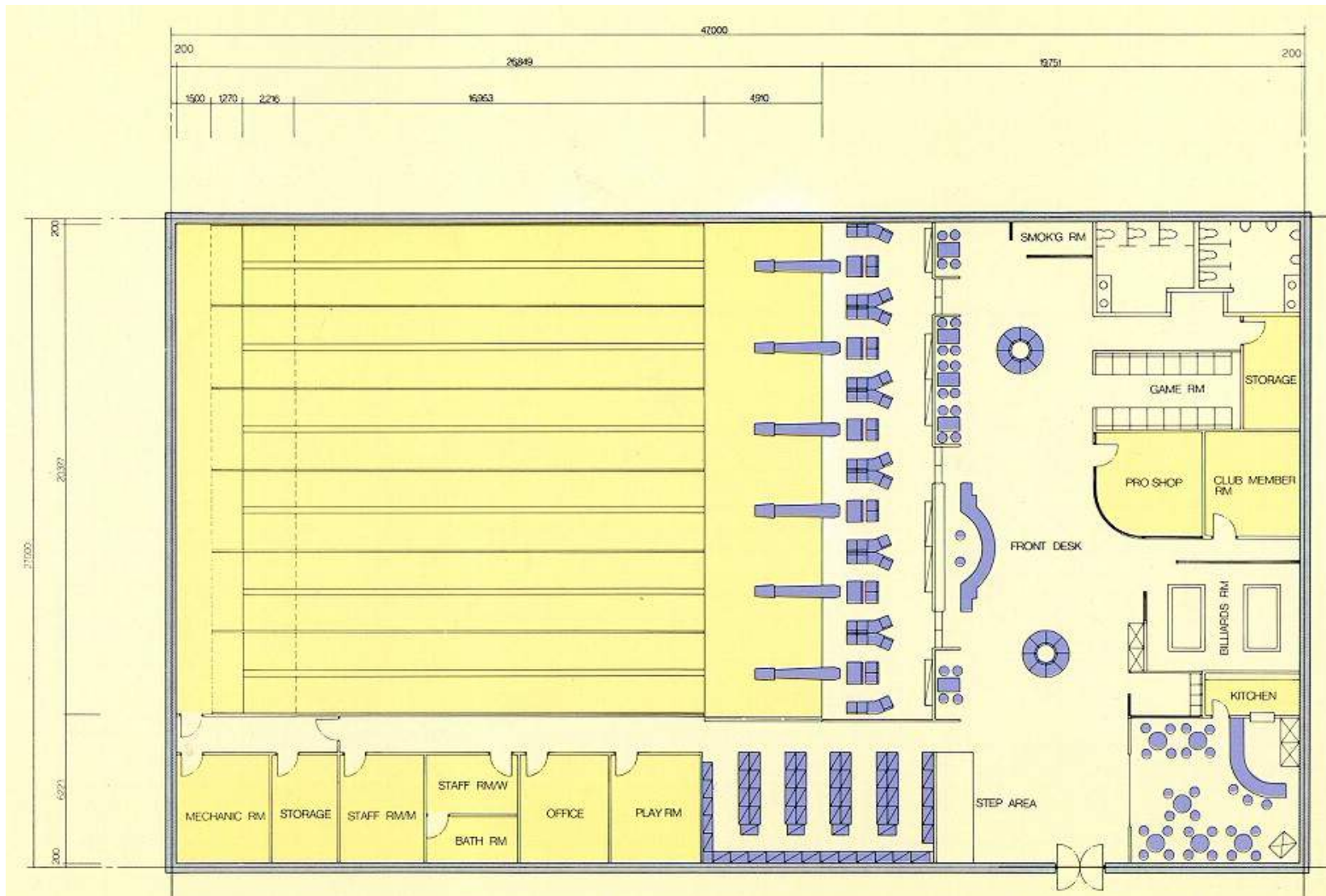

- 14-LANE LAYOUT

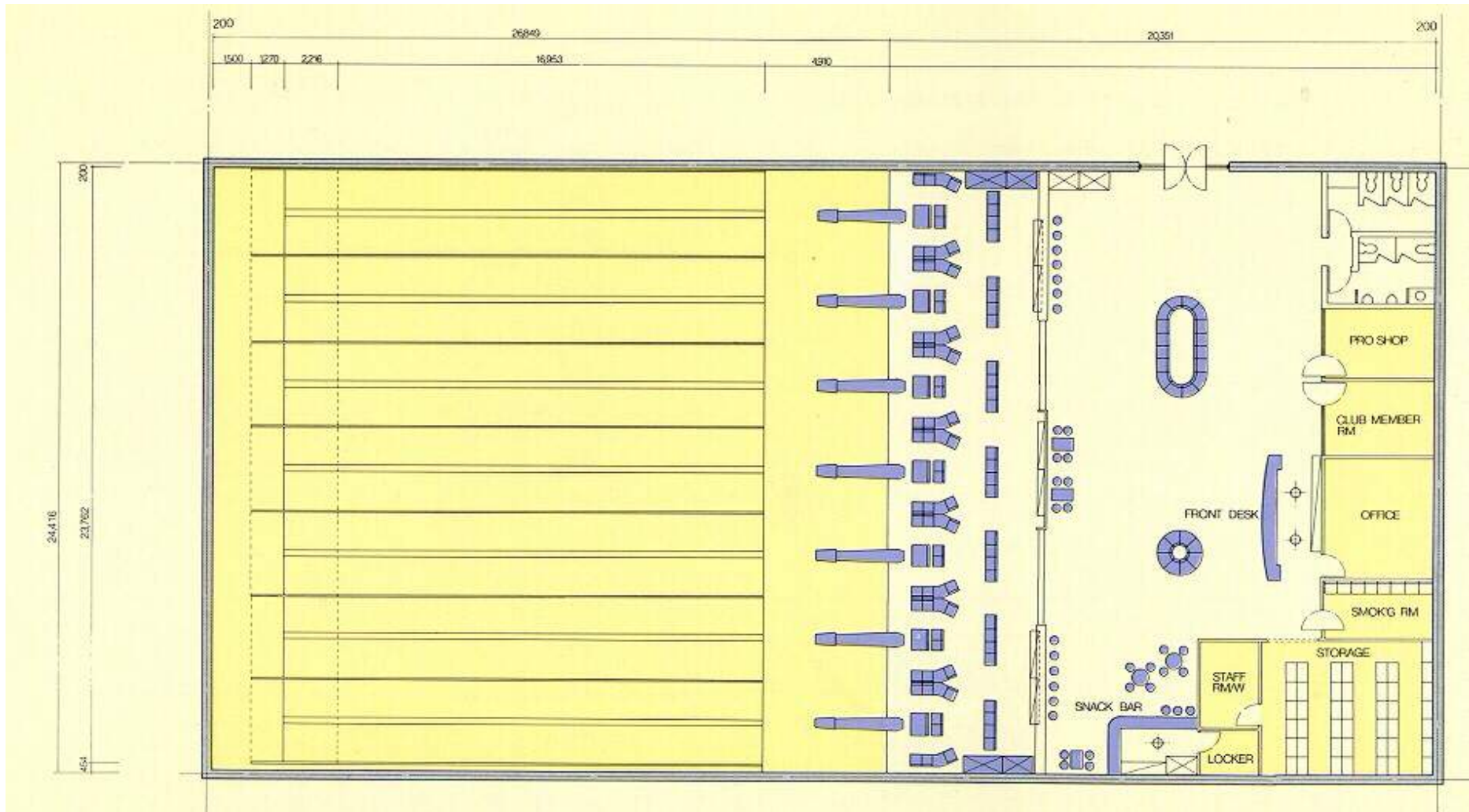

- 16-LANE LAYOUT

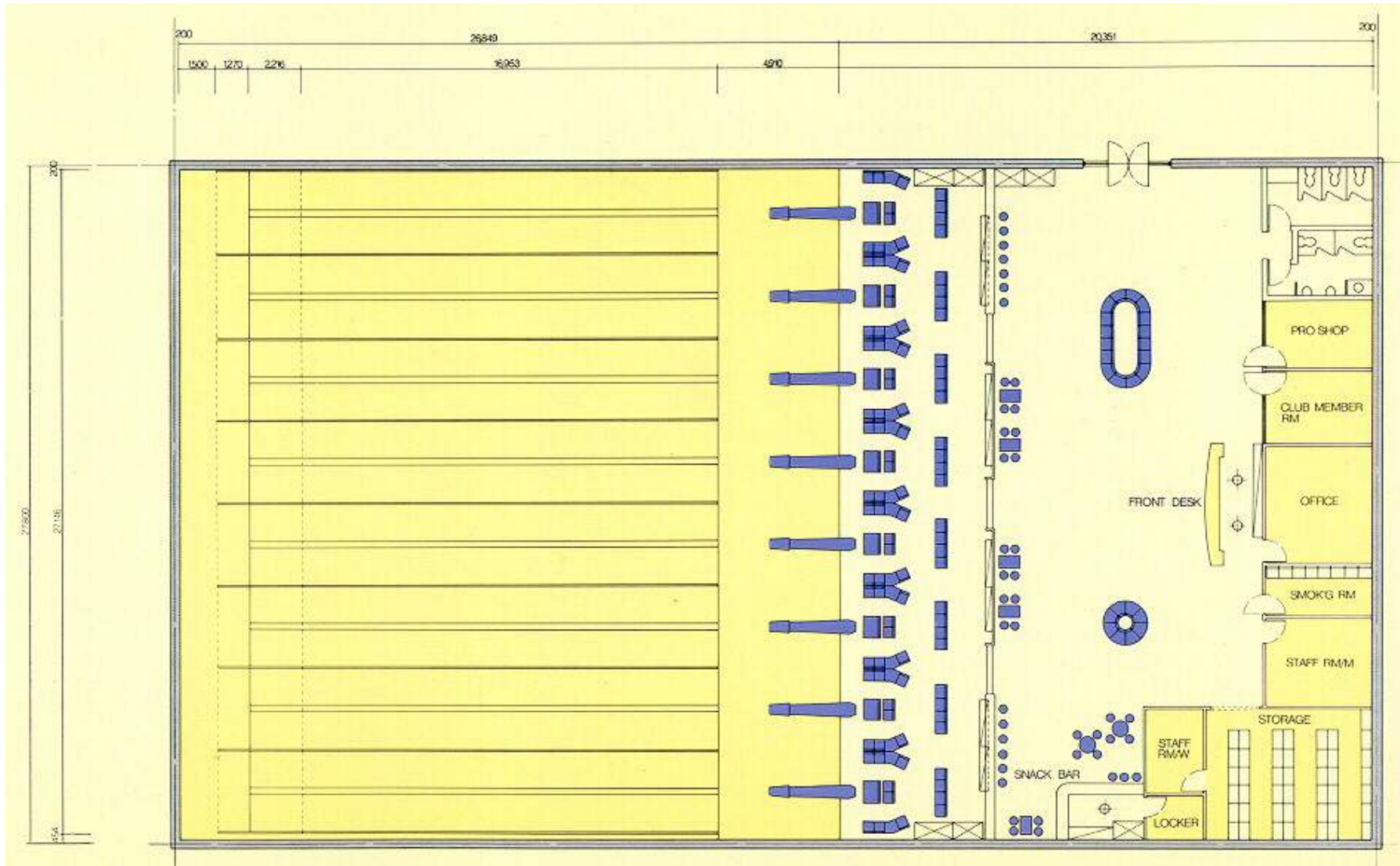

- 20-LANE LAYOUT

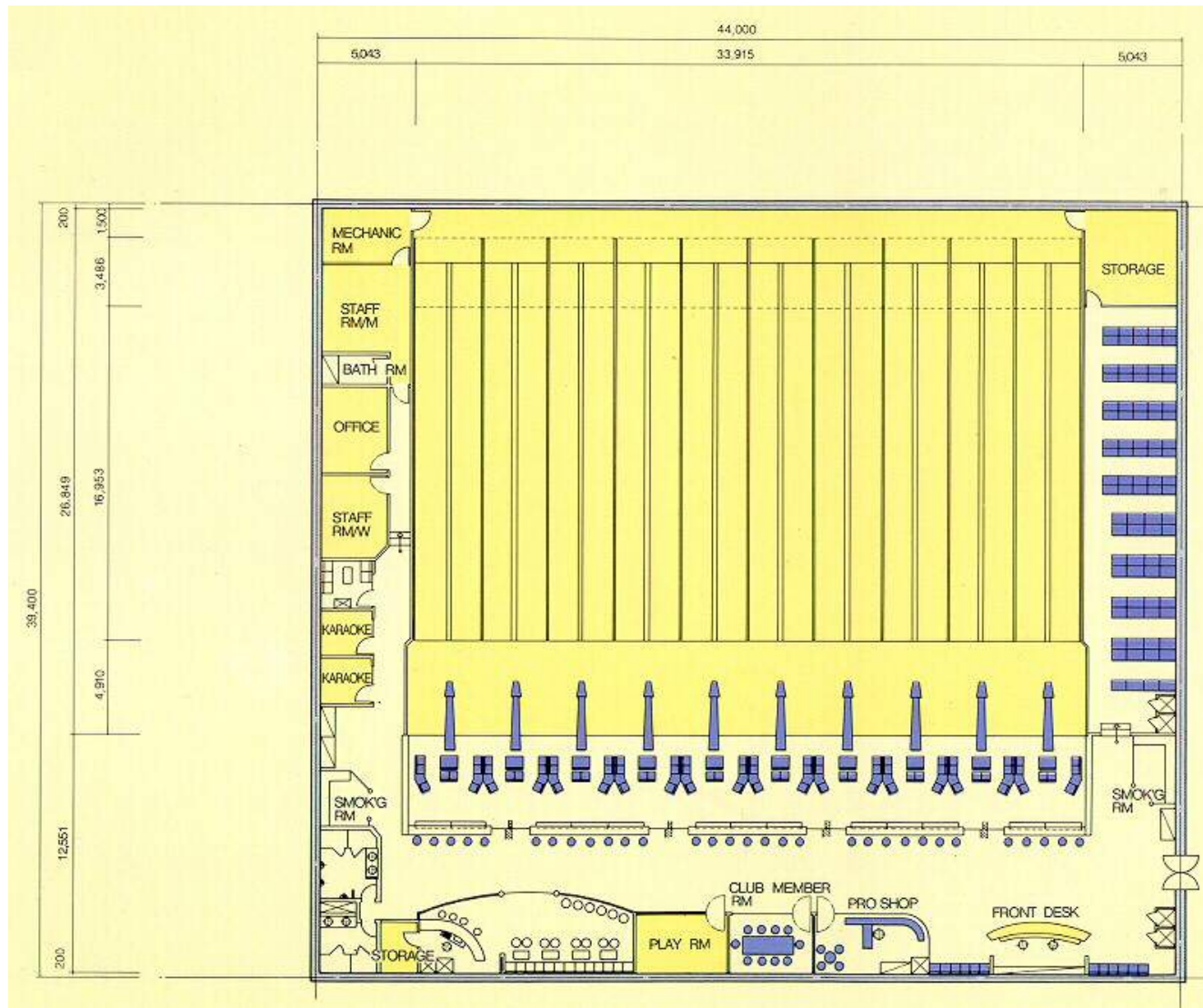

- 30-LANE LAYOUT

